

March 2020

TOYS

3

HOT ISSUE

5

MARKET REVIEW

8

BRIEF INFORMATION OF
INDONESIA'S EXPORTERS

29

LIST OF EXPORTERS OF
TOY PRODUCTS

EDITOR DESK

Dear readers,

During what many economist forecast, a global economic recession, many industries and countries are trying to survive including Indonesia. Government of Indonesia are now looking to accelerate spending to boost the economic recovery and strengthen the country's responses. The Indonesian government and industry players are also gearing up to boost export.

Toys is one of many Indonesian industries to strengthen our national export. Toy industry activities in the country have risen again. One step at a time, production utilization of the installed production capacity of national toys is moving towards to normal levels as market conditions also improve.

For this export news June edition, we are covering how well Indonesia's toy industry trade performance and giving insight for export opportunities during this economic slow movement.

Advisor:

Director General of National Export Development

Editor in Chief:

Director of Market Development and Export Information

Managing Director:

Astri Permatasari

Editor:

Farel Anjar Renato Purba

Writer:

Bunga Seruni

**Directorate General Of National Export Development
Ministry Of Trade Of Republic Of Indonesia**

M.I. Ridwan Rais Road, No. 5 Central Jakarta, Indonesia - 10110
Tel./Fax.: +62 21 385 8171, E-mail: contact-pen@kemendag.go.id



 Ditjen Pengembangan Ekspor Nasional  [djpen.kemendag](https://www.instagram.com/djpen.kemendag)

TABLE OF CONTENTS

3

HOT ISSUE

Toys Business Performance during Corona Economic Recession

5

MARKET REVIEW

Export - Import Performance of Indonesian Toy Products

8

BRIEF INFORMATION OF INDONESIA'S PRODUCTS

- CHATEDA TOYS
- FAMILY INDO PRATAMA INDUSTRY
- PT YOLITA JAYA INDONESIA
- PT MEGA ROYAL UTAMA

29

LIST EXPORTERS FOR TOYS PRODUCTS

1. PT. KAWAI INDONESIA
2. PT. AMARILYS KARISMA GEMILANG
3. PT. ABASON BABY PRODUCTS INDUSTRY
4. PT. SINAR HARAPAN PLASTIK
5. PT. LUNG CHEONG BROTHERS INDUSTRIAL
6. PT. PRIMASH INDONESIA
7. PT. GUNUNG MAS SUMANCO
8. PT. LEVY MITRA PERKASA
9. PT. CHATEDA
10. PT. SUN-INDO ADIPERSADA

HOT ISSUE

Toys Business Performance during Corona Economic Recession

The overall global sales for toy is declining due to Covid-19 effects. Nonetheless, for many people, toys are still purchased as a means of family interaction when passing through social restrictions. The Covid-19 virus outbreak had disrupted activity in several industrial cities in China. Activity in industrial cities such Dongguan and Wuhan has stopped. Hundreds of factories in Wuhan had to be closed. In Wuhan, there are approximately 515 industries, mostly in the manufacturing sector.

For this reason, it also has an impact on the toy industry of China and the rest of the world. The children's toy industry is one of the potential industry for China's economy. According to, The Wall Street Journal newspaper, it estimates about 85 percent of children's toys sold on the global market are produced in China.

The discontinue of production activities in China has a major impact on the world's toy supply chain. It was so difficult getting goods to transport toy products out of China since the lockdown happened.

Based on trademap database, United States is the major trading partner for toy products produced in China. In 2019, China had exported toys to the United States worth 62,8 billion US Dollars. Outside the US, China's toy market share is in the United Kingdom worth 19,15 billion US Dollar, Netherlands for 3,57 billion US Dollar, Japan worth 3,32 billion US Dollar and Germany for 3,21 billion US Dollar. Meanwhile China exported toys to Indonesia worth for 414,23 million US Dollar.

Despite being the world's largest toy producer, China

Due to Covid-19 outbreaks, school lessons moved to house and parents were busy doing double duty, occupying their children while try to work from home. For this reason, many parents buy toys as a way to fill the hours. Toys and games are saving lockdown for many children and parent who were forced to stay at home.

The global toy sales reached 123,86 billion US Dollar in 2019, posting a 2,48% drop over 2018 sales. Based on trademap database, the most exported for toy products in 2019 are tricycles/scooters, video game

Global Toys Sales Performance

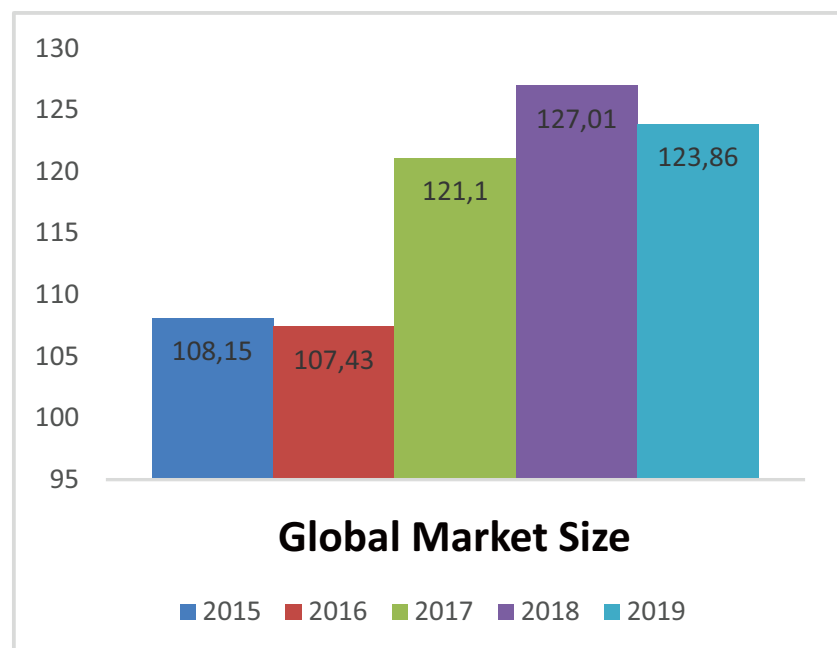

consoles, toys for physical exercise such and toys for outdoor sport.

According by The NPD Group, a leading global information company, The United States experienced the highest percentage, growth at 16%, followed by Canada (9%), Germany (9%), UK (8%), and Netherlands (6%). The U.S. toy industry experienced double-digit monthly growth from March through June, despite lockdown restrictions.

Meanwhile, all other European countries experienced declines in the first half, though combined sales in Europe were positive, up 1%. Easing of lockdown measures in Europe started in early May, and, as a result, May and June experienced respective sales increases of 9% and 11%. In the U.S.,

sales were more resilient in the first half of the year thanks in large part to the strength of the online channel in the country.

Many consumers continued to turn to Games and Puzzles more than any other category, making it the best performing for the first half (37%). Four other categories recorded growth: Outdoor & Sports Toys (27%), Building Sets (14%), Arts & Crafts (11%), and Explorative & Other Toys (1%).

It expected toy sales will continue to climb in stride along with the rise in coronavirus cases and get a boost from the strong possibility that schools around the country return to online-based learning and delay school openings.

In our domestic market,

toy industry in the country have risen again. Production



MARKET REVIEW

Export - Import Performance of Indonesian Toy Products

Export value of Indonesia's toy products to the world from January to June this year 2020 worth US \$ 2,58 billion whereas in the same period in 2019 worth US \$ 2,61 billion. Despite the weakening of global economy because of the virus outbreak, hopefully our toy product export will exceed previous year performance.

The export trend of Indonesian toy products from 2015 to 2019 was recorded to have a positive trend with growing 6,05% per year, where in 2015 the export value reached US \$ 5,25 billion and continued to grow

until reached US \$ 6,11 billion.

The main export of toy products in 2019 based on 6 digit HS classification are (1) Tricycles, Scooters, Pedal Cars And Similar Wheeled Toys; Dolls' Carriages; Dolls; Other Toys; Reduced-size (scale) Models And Similar Recreational Models, Working Or Not; Puzzles Of All Kinds, HS 950300, worth USD 6,08 billion (99,51%); (2) Festive, Carnival Or Other Entertainment Articles Including Novelty Jokes And Conjuring Tricks; Other Than Christmas Festivity Articles, HS 950590, worth USD

12,12 million (0,20%); (3) Christmas Festivity Articles, HS 950510, worth USD 9,04 million (0,15%); (4) Games; Operated By Coins, Banknotes, Bank Cards, Tokens Or By Other Means Of Payment, Other Than Billiard Articles And Accessories, And Automatic Bowling Alley Equipment, HS 950430, worth USD 6,67 million (0,11%); and (5) Games; Articles For Funfair, Table Or Parlour Games, Including Pintables, Special Tables For Casino Games, Automatic Bowling Alley Equipment, N.e.c. In Heading 9504, HS 950490, worth USD 1,69 million (0,03%).

Indonesian Toys Products

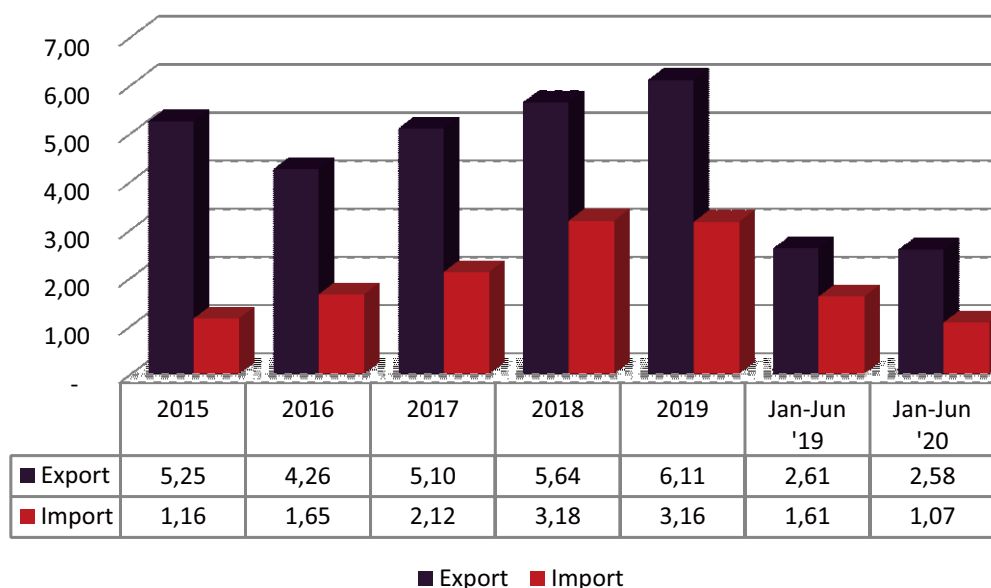

HS	COMMODITY	2019	Jan-Jun '19	Jan-Jun '20
950300	Tricycles, Scooters, Pedal Cars And Similar Wheeled Toys; Dolls' Carriages..	6.079.382	2.599.805	2.577.370
950430	Games; Operated By Coins, Banknotes, Bank Cards, Tokens Or ...	6.668	3.249	1.794
950510	Christmas Festivity Articles	9.040	1.334	1.608
950590	Festive, Carnival Or Other Entertainment ...	12.120	3.098	519
950490	Games; Articles For Funfair, Table Or Parlour Games, Including ...	1.688	307	465
950420	Billiard Articles And Accessories Of All Kinds	292	114	276
950440	Games; Playing Cards	72	50	26
950890	Roundabouts, Swings, Shooting Galleries, ...	123	3	0
950810	Travelling Circuses And Travelling Menageries	103	0	-



Indonesian government through its policy is encouraging exporters of toy products to penetrate and expand the export market. One main goal is to increase our export to the U.S. and also E.U market , in response to seize the opportunity.

As you can see on the chart, Indonesia export the biggest trading partner for the first half of 2020 is U.S (USD 958,11 million), Singapore (USD 332,18 million), U.K (USD 178,61 million), China (USD 119,84 million) and Mexico (USD 99,22 million).

Whereas, the five major trading partners for Indonesian toy products in 2019 were (1) U.S., worth USD 2,28 billion (37,3%); (2) Singapore, worth of USD 885,3 million (14,49%); (3) U.K., worth USD 516,58 million (8,46%); (4) China, worth USD 242,89 Million (3,98%); and (5) Germany, worth USD 242,05 million (3,96%).

The world biggest toy exporter is China worth for USD 40,96 billion in 2019, followed by U.S for USD 3,39 billion, Hong Kong for USD

3,24 billion, Germany for USD 3,1 billion and Czech Rep for USD 2,78 billion. Indonesia position as the toy exporter in the world is at 21st with export value for USD 425,87 million (0,59% world's share).

“Despite the weakening of global economy because of the virus outbreak, hopefully our toy product export will exceed previous year performance.”

The world biggest toy exporter

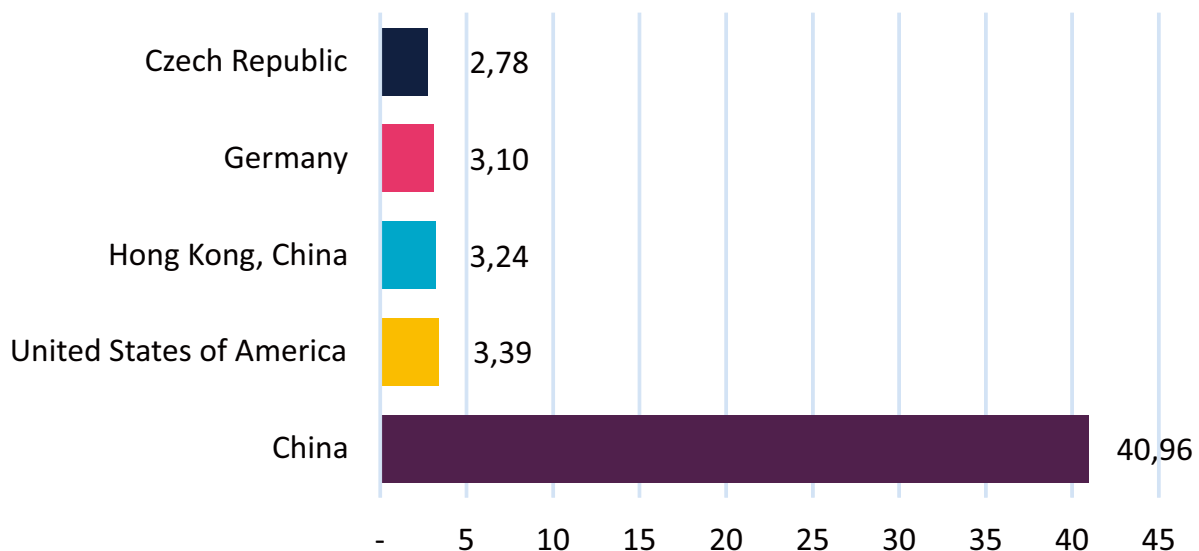

BRIEF INFORMATION OF INDONESIA'S PRODUCTS

CHATEDA TOYS

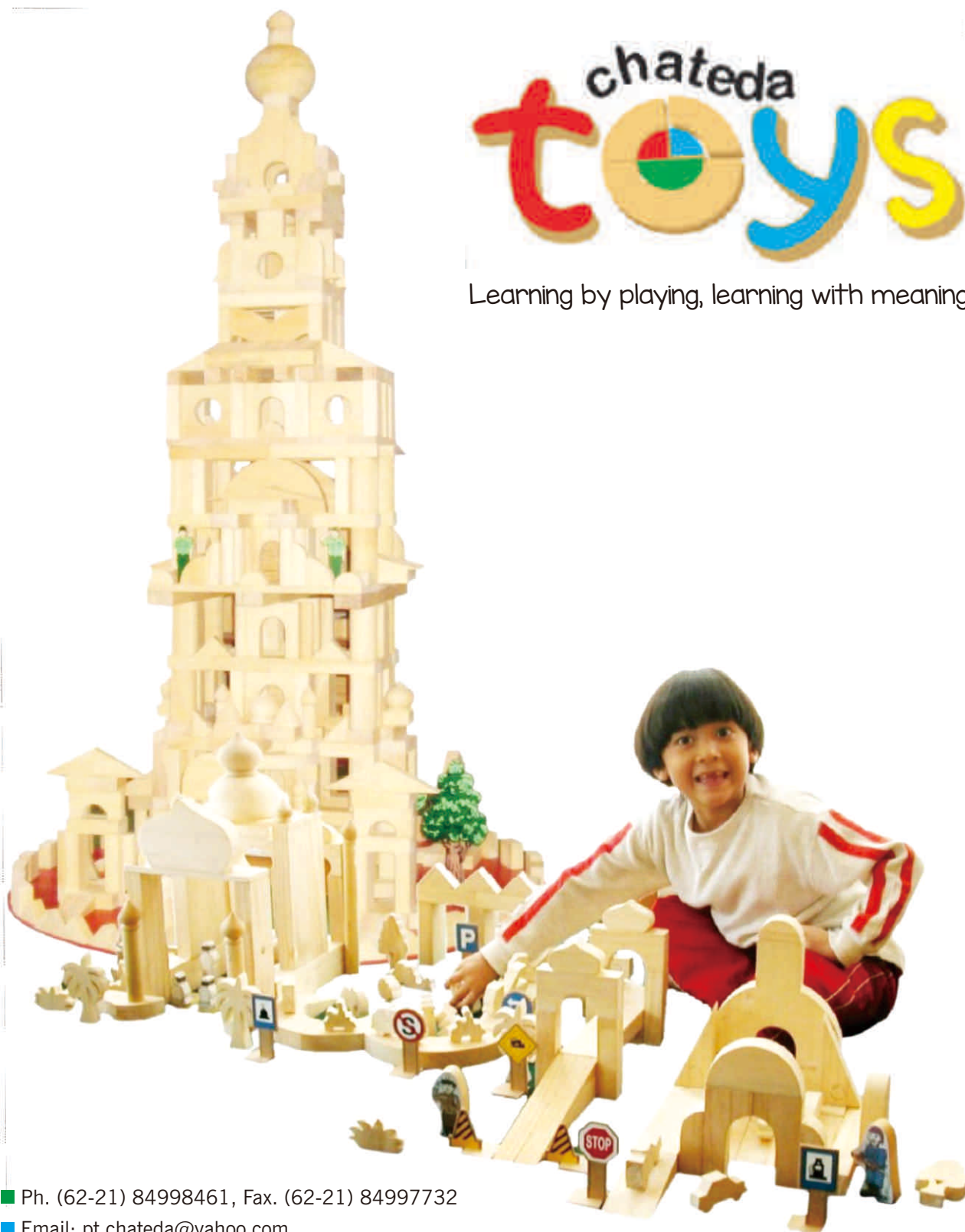

■ Ph. (62-21) 84998461, Fax. (62-21) 84997732

■ Email: pt.chateda@yahoo.com

Children live in the world of playing. Their activity and task is playing. That is why we call it learning by playing, learning with meaning. Playing is a form of education on children in early age, it is a medium of multiple intelligence learning in order to gain knowledge, skill and creativity according to their age and growth.

Playing is one of their favorite things to do and they play most of the time. Children play with their imagination and all of their heart this activity comes spontaneously to any medium they find in front of them.

Children on early age (below 3 years old) do not really have any outdoor routine. Within this phase children need a lot of assistance and supervision from the parent. Providing children with the educational toys at home is very important, however parents have to choose the right educational toys which is not only safe and comfortable for children but also has a clear purpose.

Children aged 3 to 6 years old are very observant, they need specific toys to help them develop their skills and ability based on what they see and experience in their everyday life.

Parents need to note that toys are not just for children bliss, toys also a medium of their development process. Sometimes parents or teachers choose toys which just good on the look or appearance, not because of the purpose or what their children need during their learning and development process.

Educational toy (we call it APE which stands for Alat Permainan Edukatif in Bahasa Indonesia) is a tool to help children learning by playing learning with meaning. It means the toys and the playing itself are already fun medium for children to learn. They will not get bored playing for hours but they still get the meaning and positive outcome spiritually and mentally as well as their mind and skills development.

On their early age, scientific learning process and method requires them to get involved in everything. They will have curiosity and questions about what is happening around them and by finding the answer they will start to understand.

A fun experience of playing for children which supported by the media that can precisely stimulate (stimulate) the intelligence development. The right toys will optimally motivate

children to actively construct attitude competencies, knowledge and skills through scientific stages (the ability to think in understanding the problem, analyze and creatively: observe, ask, collect information, reasoning / re-thinking and re-communicating (Kuhn & Pearsall 2000).

In this context parents, teachers, schools, professional education organizations and others, required information and knowledge in choosing the correct toys concept, with Indonesian standard (SNI) or even International standard. Very well on quality based on suitability of age and type of children form of playing. Also no less important knowledge about Safety, Safety and Health Toys and Environment (K3L)

The type of child form of play is divided into 3 stages (Charles H. Wolfgang 1977):

1. Sensory motor form of playing or Functional: Smooth and Coarse.
2. Role Play or Symbol Play : Large (macro) and Small (micro).
3. Development type of playing : More fluid with structure and construction

There are 4 types of play (Sara Smilansky, 1968):

1. Sensory motor form of playing or Functional.
2. Role Play: Micro and Macro.
3. Development type of playing : More fluid with structure and construction.
4. Play with rules.

All types of children play above should be able to stimulate (stimulate) the five senses correctly:

1. Sighting Sense (eyes);
2. Hearing Sense (ears);
3. Touching Sense (hands, feet and whole limbs);
4. Smelling Sense (nose);
5. Tasting Sense (mouth).

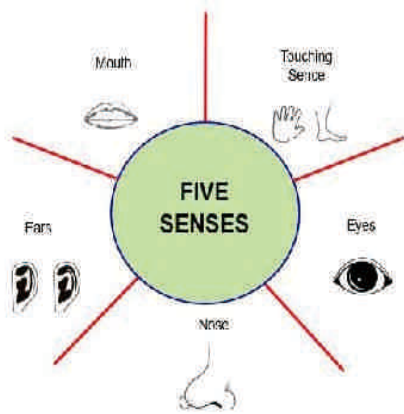

It also able to build 8 multiple intelligence on children (Howard Gardner);

1. Linguistic Intelligence
2. Logical Mathematical Intelligence
3. Musical Intelligence
4. Bodily Intelligence
5. Visual Spatial Intelligence
6. Interpersonal Intelligence
7. Intrapersonal Intelligence
8. Spiritual Intelligence

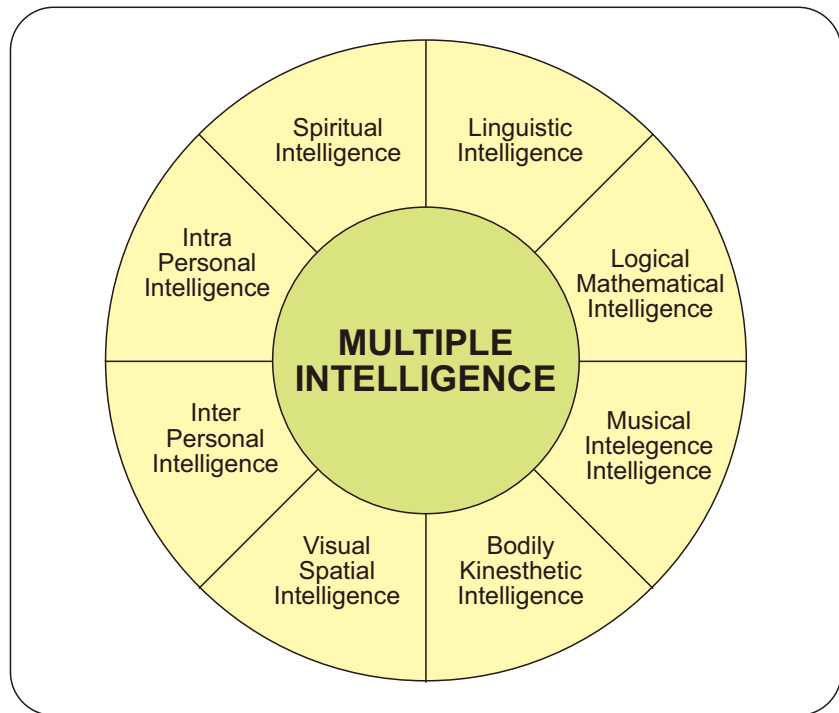

Based on the above description, the writer then creates Educational Game Tools for children which facilitate them to develop definite process of scientific, multiple intelligence and motivate children to actively think in higher playing type of process. Tend to be more constructive with the stack up wooden block (also available in Traditional Houses Theme) and to influence children to love their homeland by introducing them the natural resources with Indonesia archipelago puzzle.

All of Chateda Toys product is very high in standard using legal wood from Indonesia. Moreover Chateda Toys also produce general educational toys like puzzle, tangram, abacus, doll hous, general stack up wooden block, etc.

Thereby how Educational Toys of Chateda Toys product designed. In hopes it can be useful for the community especially for schools management, parents, teachers, children. By choosing the right toys properly the concept of education both in quality and safety which also comfortable (Health, Safety and Environmental Safety (K3L).

Love Indonesia good quality toys, be Educative, creative, innovative, with great quality standard SNI (Standard National Indonesia) accompanied by legality of Trade License NRP (Product Registration Number) making Indonesia proud within the country and abroad. Bring prosperous for the country we love through Toys made in

ABOUT CHATEDA TOYS

P.T. Chateda was established in 1997. Engaged in the consulting, design and interior-exterior procurement, event organizer, educational props provider. Then focuses on the production of Educational Game Equipment (APE) and Consultation for the establishment of Early Childhood Education Institutions, with one of the Chateda Toys divisions.

Chateda Toys started its first production for Children Toys in 2000. The first production made is Stack Up Unit Block, Block Accessories (Microplay), Puzzle, String Up, Moslem Doll House Ka'bah and Doll House Mosque, Prayer Doll, Mosque Puzzle and others.

Then Chateda Toys began to penetrate the market of educational game tools (APE) Nusantara Indonesia Stack Up Blocks, Traditional Clothes, Floor Puzzle of Islands in Indonesia, and card games. Chateda sees the opportunity when demand for toys is quite high and the competitors in this type of toy is still not much. From time to time Chateda Toys began to explore other toy variants.

Chateda Toys focus on the development, knowledge,

skills and the creativity process in building children's multiple intelligence from an early age. The products of Chateda Toys are not only to help children's motor and sensory development (functional), playing a role or symbolic, but also play constructions to introduce concept of structures and construction to the children.

Chateda Toys always priorities educational concept and quality to ensure customers satisfaction. The selection of materials from wood base to the finished products is always under control in order to ensure the best quality, precision and security of the products.

All products of Chateda Toys have been through a long trial process, from the concept, the manufacture of toys models, the study of children's playing process, to meeting the certification requirements of SNI (Indonesian National Standard) and ISO 9001-2008.



Chateda Toys products are produced handmade by the best craftsmen with over 15 years experiences to maintain consistency of size, quality, safety and durability.

Since 2001 the products of Chateda Toys have been widely used by international government educational institutions and organizations. From national to international schools, Ministry of Education and Health to United Nations organizations such as UNICEF and UNESCO, MERCY CORP and PLAN INDONESIA.



The Chateda Toys' quality and consistency is without question. One of the consultants of Chateda Toys, Pamela C. Phelps Ph.D from CCCRT (Consultant from the Creative Center for Childhood Research and Training), Tallahassee, Florida, USA (2004-2017) states, "We have seen materials created in a number of these businesses and none has the quality that can be consistently found in the blocks, puzzles and other materials created at Chateda Toys".

Vision

Being a company engaged in the field of consultancy, design, interior-exterior procurement, educational game tools (APE) that have the best educational value, complete, creative, terinovatif, which can build and optimize the area of brain development in thinking (affective aspects, cognitive, linguistic, psychomotor and social emotional) the intelligence of children with science and technology standard ISO 9001: 2008, SNI, safe and comfortable for child. With SNI certified Chateda hope to introduces Indonesia to the world with it's intellectual property, scientific value and work. Strong with a load of faith and Indonesian Culture.

Mission

- Building a positive and dynamic culture within the corporate environment simultaneously and comprehensively.
- Develop and optimize the business strategy concept and growth of the company as part of the main program.
- Produce high quality, creative and innovative products and programs to meet the demands of globalization era.
- Develop and cooperate with various parties to achieve mutual success towards the future.
- Provides customer satisfaction and trust.



PROFILE AND SELECTED PRODUCTS



Name : Andi Chandra Meutia

Company : PT. Chateda

Ph. : +62 813 9861 8665 (Chandra)
+62 878 8295 2960 (Savira)

Email : pt.chateda@yahoo.com

Website : <http://chatedatoys.com>

Legal : Company Certificate

- Domicile (Compan Location)
- NPWP (Tax Number)
- SIUP (Trading License)
- TDP (Certificate of Company Registration)
- IUI (Industry Permit)
- HAKI (Copy Rights)
- Merk Dagang (Trade Mark)
- ISO 9001-2008 (Quality Management System)
- SNI (Indonesia National Standard)
- NRP (Product Registration Number)

Product :

- Wooden Unit Block
- Block Play Role Accessories
- "Meronce" (String up) Geometric Shape
- "Meronce" (String up) Alphabet and Numbers
- Block
- Geo Board
- Puzzle
- Doll House & Furniture
- Tangram Puzzle and Pattern
- Abacus
- Wiring Game
- Mazze





"Meronce"
(String up) Alphabet



Pancasila (Indonesia's Ideology)
Puzzle Indonesia Islands Puzzle



Doll House



Traditional House Block &
Tumbler Stick

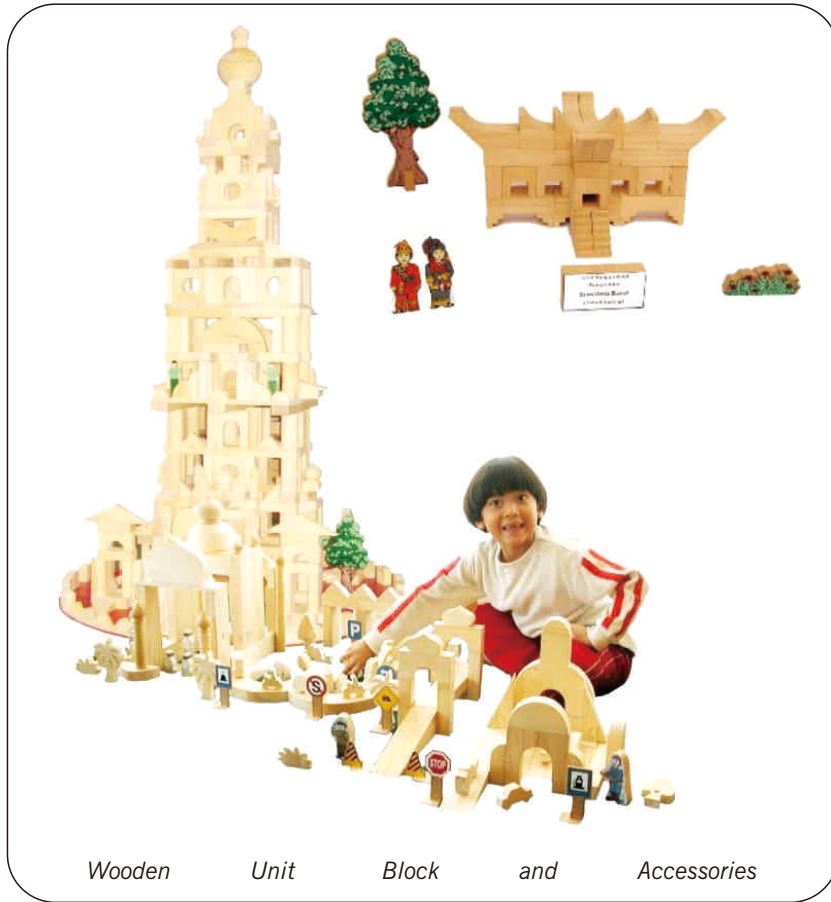

Wooden Unit Block and Accessories

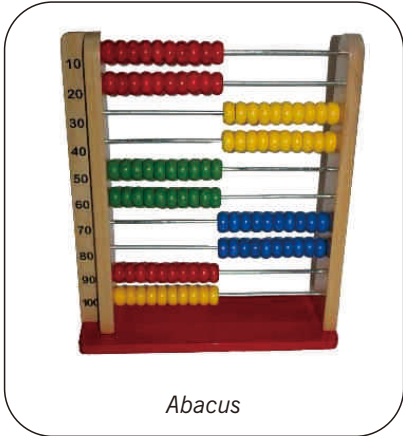

Abacus



Geo Board



Meronce 256 pcs



Carperry Tools



DH-02



RKI-01

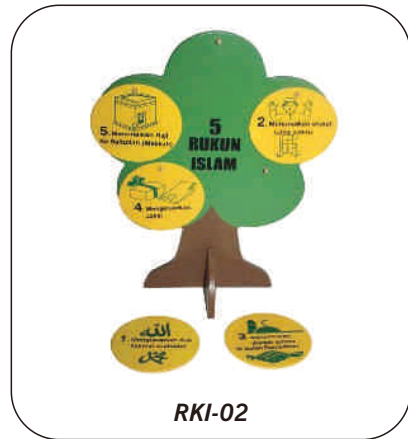

RKI-02



BK-02

DH-02



PM-03



BS-03



DH-01

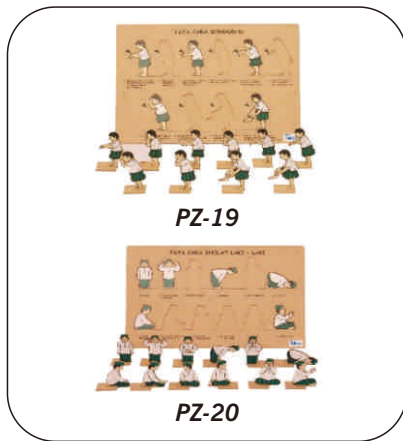

PZ-19

PZ-20

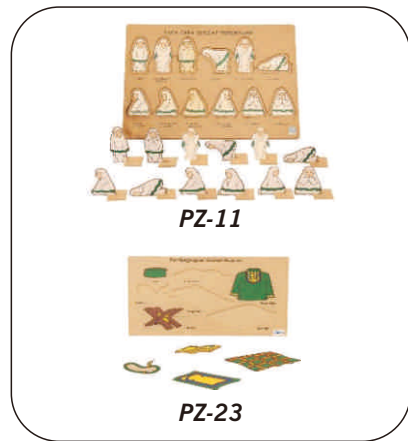

PZ-11

PZ-23

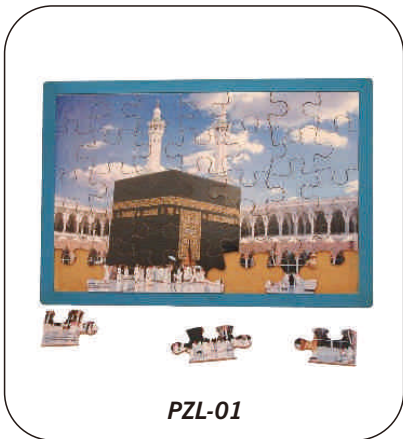

PZL-01

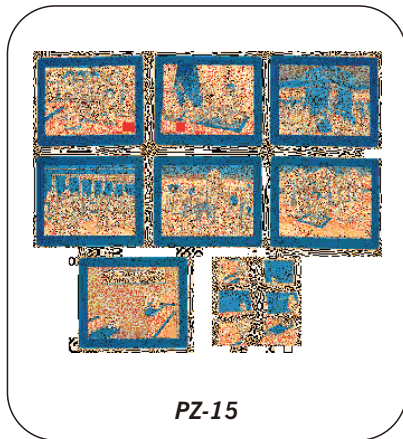

PZ-15

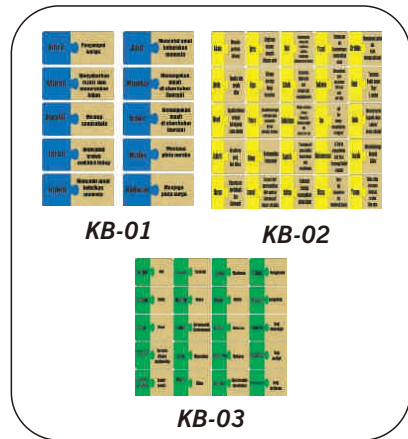

KB-01

KB-02

KB-03

LIST OF EXPORTERS OF TOYS PRODUCTS

CHATEDA TOYS

Our Happiness



#1
**Produk No. 1
Indonesia**

**NEW
CATALOGUE
2020**

NEO



www.shptoys.com

3+



Music & Light

Item Code : **NEO 553**

Size of Unit : 66 cm x 35 cm x 51 cm
 MSMT : 70 cm x 58 cm x 60 cm (0,243)
 Colours : White & Red
 Features : Music & Light
 Packs : 4 pcs

TRICYCLE

3+



Item Code : **MPR 593**

Size of Unit : 73 cm x 39,5 cm x 46 cm
 Colours : Blue & Red
 Features : Music & Handle
 Packs : 4 Pcs
 MSMT : 73 cm x 65 cm x 65 cm
 (0,308)



Item Code : **SMT 589**

Size of Unit: 71 cm x 34,5 cm x 54 cm
 Colours : Blue & Red
 Features : Music
 Packs : 4 Pcs
 MSMT : 70 cm x 65 cm x 58 cm (0,264)



Item Code : **NFB 642**

Size of Unit : 64 cm x 40 m x 51 cm
 Colours : Red
 Features : Music & Light
 Packs : 8 pcs
 MSMT : 90 cm x 61 cm x 61,5 cm
 (0,337)



3+



Item Code : **HB 620**

Size of Unit : 64 cm x 40 cm x 50 cm
 Colours : Orange, Purple, Pink
 Features : Music, Handle
 Packs : 6 Pcs
 MSMT : 83 cm x 56 cm x 53 cm (0,246)



Item Code : **LB 621**

Size of Unit : 62 cm x 40 cm x 50 cm
 Colours : Orange, Purple, Pink
 Features : Music, Light, Handle
 Packs : 6 Pcs
 MSMT : 81 cm x 57 cm x 57 cm (0,264)



A Item Code : **FB 666**

Size of Unit : 64 cm x 40 cm x 50 cm
 Colours : Black
 Features : Music & Light
 Packs : 6 Pcs
 MSMT : 87 cm x 55 cm x 62 cm (0,297)



B Item Code : **FB 581**

Size of Unit : 64 cm x 40 cm x 50 cm
 Colours : Black
 Features : Music
 Packs : 6 Pcs
 MSMT : 87 cm x 55 cm x 62 cm (0,297)

3+



Item Code : **SFR 615**

Size of Unit : 62 cm x 40 cm x 50 cm
 Colours : Green, Pink, Red
 Features : Music, Light, Handle
 Packs : 6 Pcs
 MSMT : 69 cm x 63 cm x 79 cm (0,343)



Item Code : **SGB 618**

Size of Unit : 63 cm x 44 cm x 51 cm
 Colours : Purple, Orange, Pink
 Features : Music, Light, Handle
 Packs : 6 Pcs
 MSMT : 83 cm x 56 cm x 53 cm (0,246)



Item Code : **SFB 613**

Size of Unit : 62 cm x 40 cm x 50 cm
 Colours : Green, Purple, Red
 Features : Music, Light, Handle
 Packs : 6 Pcs
 MSMT : 69 cm x 63 x 79 cm (0,344)



www.shptoys.com

3+



With Music & Light



With Light



Item Code : **Scooter 609**

Size of Unit : 72 cm x 37 cm x 55 cm
 Colours : Pink, Blue, Red, Yellow
 Features : Music
 Packs : 4 Pcs
 MSMT : 70 cm x 61 cm x 61 cm (0,299)



www.shptoys.com

3+



Item Code : **MV 616**

Size of Unit : 73 cm x 29 cm x 33 cm

Colours : White, Green, Red, Yellow

Features : Music, Light, Handle

Packs : 4 Pcs

MSMT : 72 cm x 55 cm x 70 cm (0,277)

Cool Kids ^{Can} Rock



www.shptoys.com

3+

ODDO

SIZE OF UNIT : CM X CM X CM

COLOURS : RED

FEATURES : MUSIC, LIGHT, HANDLE

PACK : PCS

MSMT : CM X CM X CM



Item Code : **ROCKER 673**

SIZE OF UNIT : 74 CM X 36 CM X 61 CM
 COLOURS : BLACK
 FEATURES : MUSIC, LIGHT, HANDLE
 PACKS : 4 PCS
 MSMT : 73 CM X 65 CM X 65 CM
 (0,308)

FAMILY INDO PRATAMA INDUSTRY



858toys (PT. Family Indo Pratama Industry) is a local company in the field of children's toys in Indonesia with more than 15 years of experience. Our company is managed by qualified and trusted human resources, working with customers from more than 100 distributors in Indonesia.

In terms of production, 858toys started its business from importing toy products to Indonesia. As time goes by

and the commitment to develop domestic products, currently 858toys children's toys have been produced in Indonesia with high quality materials and attractive designs. Even today, 858toys already has injection machines, blowers, and other machines that support the creation of toy products that can provide education and happiness to children.

VISION

Giving happiness to Indonesian children

MISSION

Provide education, make children as people who are

creative, confident, and happy through quality toy products

COMPANY CULTURE

FUN

Always bring joy at work, environment and society

TEAM WORK

The desire to cooperate with others to realize a more maximal goal

HARD WORKING

Work with passion and high commitment

CREATIVITY

Give fresh solutions to new situations

PRODUCTS



POLICE MOTORCYCLE



HULA HOOP



TALKING TOM



TAMIYA CARS



BADMINTON SET



ROCKING DUCK

GROWTH

To grow in 7 pillars:

1. Health
2. Wealth
3. Relationship
4. Spiritual
5. Social
6. Mental
7. Legacy

RESPECT

Respect and respect each other sincerely

OWNERSHIP

Feel the ownership of the company as its own

INDONESIA

Proud of INDONESIA

PT YOLITA JAYA INDONESIA



PT. YOLITA JAYA INDONESIA

PT. Yolita Jaya Indonesia is a manufacturing company that produces raincoats and inflatable toys. Founded in 1969, PT. Yolita Jaya Indonesia started as a home industry in carton and plastic printing in Bandung. In 1973, it started to produce school bags, shopping bags and other types plastic packaging.

Since 1981, the company started producing inflatable toys and rainwear. In 1982, the company expands its local sales office at several major cities in Indonesia. Since 1988, PT. Yolita Jaya Indonesia starts expanding its market internationally, the company starts exporting to Europe, Japan, Australia and USA. With more than 48 years of experience, PT. Yolita Jaya Indonesia continues to produce products that are of good quality, safe and comfortable to be used.

PT. Yolita Jaya Indonesia moves forwards "to be market leader in rainwear products and swimwear products in Indonesia"

To support that vision, we are committed:

1. To give satisfaction to Customer, Supplier, Employees and Stake Holder
2. To create and innovate quality products that are safe and comfortable to be used
3. To develop human resources that prepares for global market

PT Yolita Jaya Indonesia has been implementing Quality Management System, ISO 9001:2015.

CERTIFICATIONS ISO 9001:2015



The standard is used by organizations to demonstrate their ability to consistently provide products and services that meet customer and

regulatory requirements and to demonstrate continuous improvement.



EN 71

Specifies safety requirements for toys. Compliance with the standard is legally required for all toys sold in the European Union



ASTM

Formerly known as American Society for Testing and Materials, is an international standards organization that develops and publishes voluntary consensus technical standards for a wide range of materials, products, systems, and services.

SNI stands for Indonesia National Standard or typically called standard quality for certain product that obtained by way of (third-party) product certification system to determine the conformity of a product with specified requirements through initial

testing of samples of product, assessment and surveillance of the involved quality system, and surveillance by testing of

product samples taken from the factory or the open market, or combination of both.

SNI



PRODUCTS - INFLATABLE TOYS



QUACKER PLUS



RACKET TENNIS TURTLE



FLIPER DANCING PIRATES



PIRATES SWIMVEST



RAIN COAT TIGER HEAD SERIES Coat Big Top



Stretch Batik Mega



RAIN CITY SERIES Paramount Scotchligh



Ritz Poncho



RALEN STAR SERIES JH Poncho

PT MEGA ROYAL UTAMA

PT MEGA ROYAL UTAMA is Indonesia most innovative's Tricycles, Babywalkers & Ride-On-Cars manufacturer. We have our own State-of-the-Art Designing Team that keep developing new models, and solid Quality Inspection Group. This makes us becoming the

fastest growing toys company in Indonesia & the 1st toys company to obtain Indonesia National Certification (SNI) for Quality System.

Our products have won wide recognition and sold well on markets in many countries

and regions including Europe, America, South America, South East Asia and The Middle East. We sincerely welcome all customers around the world to give your suggestions and ideas and thus establish a long term business relationship with us.

PRODUCTS: *BABYWALKER*

BABY CLASSIC SERIES



RY-333

SPECIFICATION PRODUCT :

- HEIGH ADJUSTABLE
- 8 WHEELS
- ROLLER BALL TOYS



RY-999

SPECIFICATION PRODUCT :

- PIANO + ANIMAL MELODIES
- 8 WHEELS



RY-2288

SPECIFICATION PRODUCT :

- IC MUSIC
- TOY RAC
- PUSH BAR

COMPACT SERIES



RY-998

SPECIFICATION PRODUCT :

- IC MUSIC DRUM
- PUSH BAR

ROCKER 2IN1 SERIES



RY-9389

SPESIFICATION PRODUCT :

- PIANO MUSIC
- PUSH BAR
- FOOTWEAR MUSIC

TRICYCLE PLANE SERIES



RY-3098C

SPESIFICATION PRODUCT :

- INTERACTIVE SAFETY BAR
- IC MUSIC + DISCO LIGHT
- REAR STEER
- FOOT TRAY
- DOUBLE SEAT
- CANOPY

ROBOT SERIES



RY-19282 C

BMX SERIES



RY-3788 SC



RY-3288 N

**RIDE ON TOYS
CAR SERIES**



RY-108 S
 SPESIFICATION PRODUCT :
 • IC SIRINE MUSIC
 • PUSH BAR
 • FOOT STEP

TRIKE SERIES



RY-618 HYPO

**ELECTRIC CARS
ATV SERIES**



RY-808 ATV SPEED
 SPESIFICATION PRODUCT :
 • RECHARGEABLE BATTERY MOTOR
 • FORWARD AND REVERSE MOVING
 • EXCITING MUSIC
 • IC MUSIC
 • DISCO LIGHT

**ACCESSORIES WITH MUSIC
BABY INTERACTIVE MUSIC**



SAFARI MUSIC
 SPESIFICATION PRODUCT :
 • INTERACTIVE MUSIC
 • STIMULATE THE IMAGINATION
 • BRAIN TRAIN INTELLIGENCE

**TRICYCLE
INTERACTIVE MUSIC**



POLICE SAFETY BAR
 SPESIFICATION PRODUCT :
 • INTERACTIVE MUSIC
 • STIMULATE THE IMAGINATION
 • BRAIN TRAIN INTELLIGENCE

LIST OF EXPORTERS OF TOYS PRODUCTS

1. PT. KAWAI INDONESIA

KIIC Jl. Maligi Raya Lot J4 A-C, Teluk Jambe Timur, Cikarang, Karawang, Jawa Barat

Ph. (62-21) 89108947, Fax (62-21) 89108948

Email: tudi@kawai.co.id; umetsu@indosat.net.id; carol@kawai.co.id; nandar@kawai-id.com

2. PT. AMARILYS KARISMA GEMILANG

Jl. Raya Balapulang No. 60 RT. 08/RW. 05, Balapulang Wetan, Tegal, Jawa Tengah

Ph. (62-283) 3467299, Fax (62-283) 3476296

Email: christianti_rusli@yahoo.co.id, amarilyskg09@yahoo.co.id, m.yessy.r@gmail.com, fajar_ikmal17@yahoo.co.id

3. PT. ABASON BABY PRODUCTS INDUSTRY

Jl. Raya Driyorejo Km. 25,5 Desa Krikilan (Po Box. 1514), Gresik, Jawa Timur

Ph. (62-31) 7420963, 7344235, 7344285, 7507366, 731269

Fax. (62-31)7507369, 7343969, 7420961

Email: marketing@abason.com, lielie_fs@yahoo.com, acc_arm@yahoo.com

4. PT. SINAR HARAPAN PLASTIK

Kapuk Kamal Indah Kav. I No. 2, Komplek Pergudangan Kamal Indah RT. 02/RW. 01
Kel. Kamal - Kec. Kalideres, Jakarta Barat, DKI Jakarta

Ph. (62-21) 55952063, 55952065, 55952062, Fax. (62-21) 55952061

Email: enquiry@shptoys.com, harytio@gmail.com, shp.thio@gmail.com, esther.shp7@gmail.com

Website: www.shptoys.com

5. PT. LUNG CHEONG BROTHERS INDUSTRIAL

Jl. Raya Serang Km. 90, Sentul Kragilan, Serang, Banten

Ph. (62-254) 281888, Fax. (62-254) 281777

Email: conson@ptlcbi.com, Andy.Wong@e-lci.com, iskandar@ptlcbi.co.id

Website: www.ptlcbi.com

6. PT. PRIMASH INDONESIA

Jl. Pangkalan 1B RT. 01/06, Bantar Gebang, Bekasi, Jawa Barat

Ph. (62-21) 8254033, Fax. (62-21) 82600505

Email: prima_sh_indonesia@yahoo.com

7. PT. GUNUNG MAS SUMANCO

Jl. Kalilom Lor Baru II No. 25-27, Surabaya, Jawa Timur

Ph. (62-31) 3760164, Fax. (62-31) 3769139

Email: gmsumanco@gmail.com

8. PT. LEVY MITRA PERKASA

Jl. Raya Indah Raya Blok CC No 1A, Harapan Indah, Bekasi, Jawa Barat

Ph. (62-21) 8871065, Fax. (62-21) 8871065

Email: levy@cbn.net.id

9. PT. CHATEDA

Jl. Jatibening Raya Ruko Villa Jatibening Tol BI KH/8, Jati Bening - Pondok Gede, Bekasi, Jawa Barat

Ph. (62-21) 84998461, Fax. (62-21) 84997732

Email: pt.chateda@yahoo.com

10. PT. SUN-INDO ADIPERSADA



Jl. Raya Cileungsi -Bekasi Km. 22,5, Cileungsi (PO BOX 8), Bogor, Jawa Barat

Ph. (62-21) 8230272, 8230273, HP : (62-856) 93265459, Fax. (62-21) 8230264

Email: sales@indopals.com, marketing@indopals.com, wa.fristi@gmail.com, ikin_asikin@hotmail.com, martin.tirtha@yahoo.com, enricoprata@yahoo.com.br

**Directorate General Of National Export Development
Ministry Of Trade Of Republic Of Indonesia**

M.I. Ridwan Rais Road, No. 5 Central Jakarta, Indonesia - 10110
Tel./Fax.: +62 21 385 8171, E-mail: contact-pen@kemendag.go.id

 Ditjen Pengembangan Ekspor Nasional  [djpen.kemendag](https://www.instagram.com/djpen.kemendag)